

G = *Zincato*

G = *Galvanizzato*

G = *Zinque*

G = *Galvanizado*

G = *Docinčan*

G = *Zincat*

Cardini, perni e battenti per cancelli

d = Diametro

d = Diameter

d = Diamètre

d = Diámetro

d = Dromjer

d = Diametru

Hinges and plates



R 722.299 foro = 30 mm **G** H = 35 mm F = M18
 R 722.300 foro = 35 mm **G** H = 40 mm F = M22
 R 722.301 foro = 40 mm **G** H = 45 mm F = M27

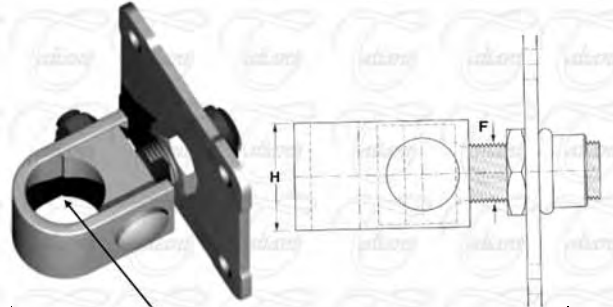

R 722.320 foro = 30 mm **G** H = 35 mm F = M18
 R 722.321 foro = 35 mm **G** H = 40 mm F = M22
 R 722.322 foro = 40 mm **G** H = 45 mm F = M27

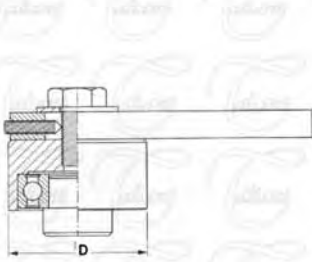

R 722.340 D = 40 mm **G**
 R 722.341 D = 50 mm **G**
 R 722.342 D = 60 mm **G**
 R 722.343 D = 70 mm **G**

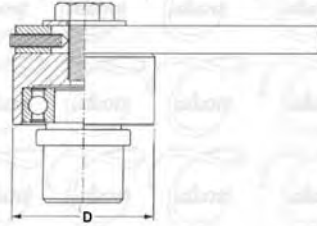

R 722.360 D = 60 mm **G**
 R 722.361 D = 70 mm **G**

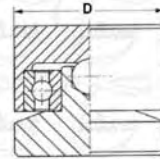

R 722.368 D = 40 mm **G**

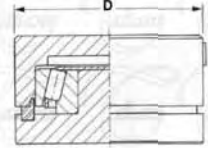

R 722.375 D = 50 mm **G**
 R 722.376 D = 60 mm **G**
 R 722.377 D = 70 mm **G**

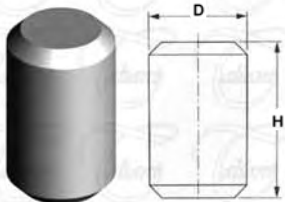

R 723.100 D = 30 mm H = 50 mm
 R 723.101 D = 35 mm H = 55 mm
 R 723.102 D = 40 mm H = 70 mm

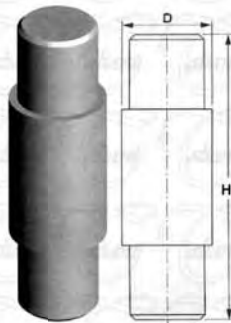

R 723.110 D = 30 mm H = 110 mm
 R 723.111 D = 35 mm H = 115 mm
 R 723.112 D = 35 mm H = 115 mm
 R 723.114 D = 40 mm H = 130 mm

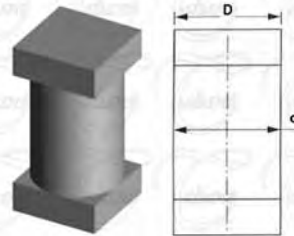

R 723.130 D = 30 mm d = 30 mm
 R 723.131 D = 35 mm d = 35 mm
 R 723.132 D = 40 mm d = 40 mm

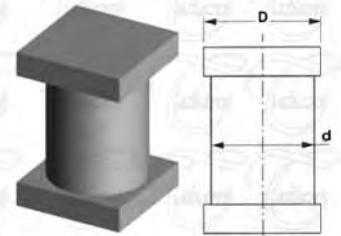

R 723.140 D = 35 mm d = 30 mm
 R 723.141 D = 40 mm d = 35 mm
 R 723.142 D = 50 mm d = 40 mm



R 723.160 D = 30 mm
 R 723.161 D = 35 mm
 R 723.162 D = 40 mm

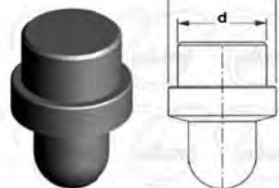

R 723.168 D = 30 mm d = 24 mm
 R 723.169 D = 35 mm d = 29 mm
 R 723.170 D = 35 mm d = 34 mm
 R 723.171 D = 40 mm d = 34 mm



R 723.190 H = 70 mm **G**
 R 723.191 H = 86 mm **G**

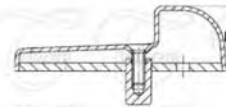

R 723.198 H = 31 mm **G**
 R 723.199 H = 39 mm **G**

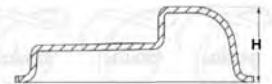

R 723.202 H = 37 mm **G**
 R 723.203 H = 44 mm **G**

